

## Section 8 - Repair Parts List

### 8.1 Wheels and Casters

**TW Transport** For models: SP50-300TW, SP50-400TW and SP50-500TW

1	<b>Part no. SP-270</b>	Caster-Swivel 12" x 3" MO, RT, RB
2	<b>Part no. SP-270-1</b>	Wheel, 12" x 3" Rubber, Roller Bearing, 3 1/2" Hub Length, 1" Axle
3	<b>Part no. SP-271</b>	Wheel, 16" x 4" Rubber, Roller Bearing, 4 1/4" Hub Length, 1-1/4" Axle (For SP50-300TW, SP50-400TW)
3	<b>Part no. SP-275</b>	Wheel, 16" x 4" Rubber, Roller Bearing, 5 1/4" Hub Length, 1-1/4" Axle (For SP50-500TW.)



## 8.2 SP50 PUMP









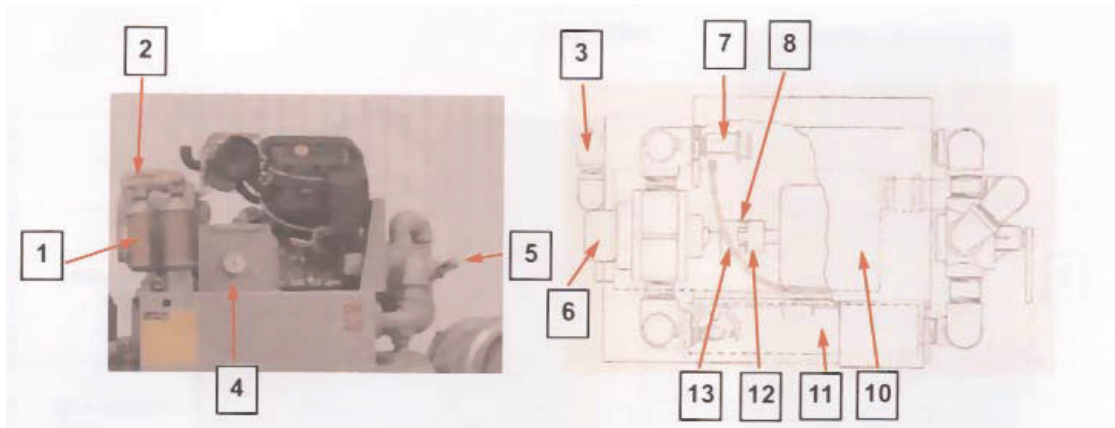



For models:

SP50-300TW  
SP50-400TW  
SP50-500TW

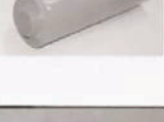
SP50-300PM  
SP50-400PM  
SP50-500PM

SP50-300CB1  
SP50-400CB1  
SP50-500CB1  
SP50-600CB1



1	SP-442	Muffler, 1", 410		8	SP-529	Flexible Coupling Spider	
2	SP-443	Pressure Relief Valve, 1", 7 psi		9	A220-277	Flexible Coupling, 2" Pipe	<i>Not Pictured</i>
3	SP-446	Pressure Relief Valve, 1-1/4" x 1-1/2", 8 psi		10	SP-441	Muffler, 22070	
4	SP-195	Vacuum Pressure Gauge, 2-1/2" Back Mount		11	SP-394	Muffler, U5-1-1/2	
5	SP-444	4-Way Valve, 2"		12	SP-515	Flexible Coupling Body, 1"	
6	SP-388	Vacuum Pump, 3MVF		13	SP-528	Bore Flexible Coupling Body, 3/4" Bore	
7	SP-506	Vacuum Relief Valve, 1"		14	A210-148	Float Control Assembly (2 balls), 1-1/4"	

SP50 EXTRA POWER Sumpcleaner/Filter





## 8.4 FILTER COMPONENTS

For models:

SP50-300TW  
SP50-400TW  
SP50-500TW

SP50-300PM  
SP50-400PM  
SP50-500PM

SP50-300CB1  
SP50-400CB1  
SP50-500CB1  
SP50-600CB1

F50 Filter

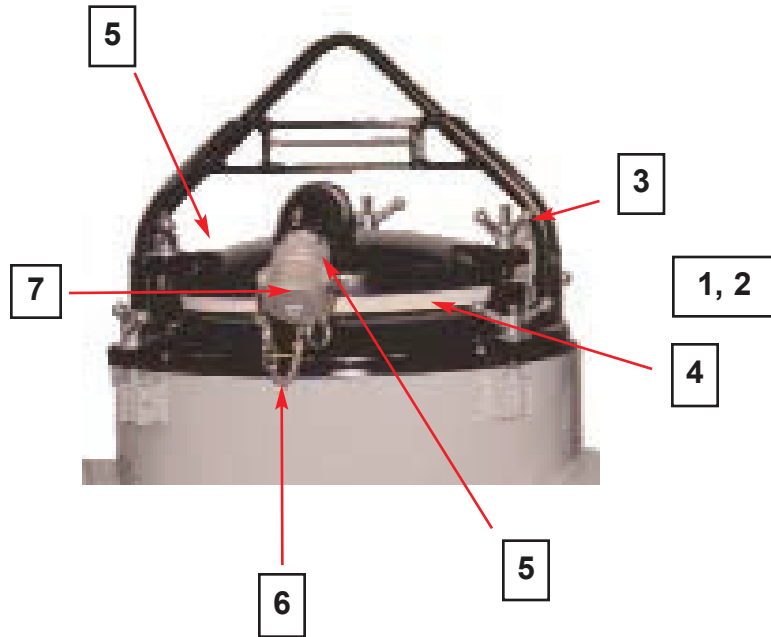

SP50 EXTRA POWER Sumpcleaner/Filter

1		A-220-336	FILTER SLEEVE, POLYPROPYLENE FOR F-50	5		SP-375	DISCONNECT ADAPTER, 2" MALE THREADS, F
2		A-220-583	FILTER SLEEVE, WHITE, FINE WEAVE	6		SP-373	6" SECURITY CHAIN
3		SP-386	WING NUT, 5/8-11	7		SP-374	DISCONNECT CAP, 2", V
4		A-220-274	FILTER LID GASKET, F-50				



**8.5 TOOLS & ACCESSORIES**

For models:

SP50-300TW  
SP50-400TW  
SP50-500TW

SP50-300PM  
SP50-400PM  
SP50-500PM

SP50-300CB1  
SP50-400CB1  
SP50-500CB1  
SP50-600CB1

SP50 EXTRA POWER Sumpcleaner/Filter

1		A-210-965	STRAIGHT NOZZLE (FITS 2" HOSE)
2		A-220-151	FLARE NOZZLE (FITS 2" HOSE)
3		A-220-152	FLEXIBLE NOZZLE (FITS 2" HOSE)
4		A-220-562	NOZZLE VALVE, 1"
5		A-220-147	HOSE ASSEMBLY, 2" I.D. X 16' LONG, CLEAR
5		A-220-147R	HOSE ASSEMBLY, 2" I.D. X 16' LONG, RED
6		A-220-145	DISPENSING HOSE ASSEMBLY, CLEAR, 1-1/4" I.D. X 16' LONG
7		SP-262-BN2	GASKET FOR 2" DISCONNECT SET
8		SP-198-2	DISCONNECT COUPER, 2", FEMALE THREADS
9		A-220-624	FLOOR SQUEEGEE, 2"

